



Owner's Manual



SANCO₂ Heat Pump Water Heater with Natural Refrigerant(CO₂)

**Heat Pump Units : GS5-45HPC
GS5-45HPC-D**

**Tanks : SAN-43SSAQA/ECO-43SSAQB
SAN-83SSAQA/ECO-83SSAQB
SAN-119GLBK/ECO-119GLBB**



This appliance is not to be used by persons (including children) with reduced physical, sensory or mental capabilities, or lack of experience and knowledge, unless they have been given supervision or instruction. Children being supervised not to play with the appliance. This appliance is not to be installed by unqualified and unlicensed persons, please read and understand this manual prior to installing and operating the unit.

Contents

Page title	1
Contents	2
Introduction.....	3
How It Works.....	3
Installation Details.....	8
Trouble Shooting Guide	9
Error Codes	10
Filling the System & Bleeding Air	11
Mains Power/Electrical Installation	12
Electrical Connections	12
How to Connect Main Power	13
How to Connect Thermistor Cable and Modbus Cable	14
Standard System Operation	14
System Operation If Connected to Dry Contact	15
Water Supply Quality	16
Technical Data	17
Warranty Policy	19
Registration for Warranty	24
Memo	25

PATENTS

This water heater may be protected by one or more patents or registered designs in the name of ECO2 System LLC

TRADE MARKS

® Registered trademark of ECO2 Systems LLC

Note: Every care has been taken to ensure accuracy in preparation of this publication.
No liability can be accepted for any consequences that may arise as a result of its application.

Introduction

The SANCO₂ Heat Pump Water Heater System has been designed using the latest refrigeration technology to remove the heat from the air to heat water. The refrigerant we use is CO₂ which does not contribute to global warming so it allows us to help keep a clean healthy earth for future generations.

We have also considered the power requirement. By using CO₂ as the refrigerant, we have produced one of the most energy efficient units currently available. It is even more efficient when connected to demand response power and the noise level is so low it will operate unobtrusively throughout the night.

How It Works

The Heat Pump Water Heater System heats water by transferring the heat from the surrounding air to the water using a refrigerant. The refrigerant is heated by a heat exchanger that absorbs heat from the surrounding air (Figure 1).

Figure 1: Heat Pump Water Heater System

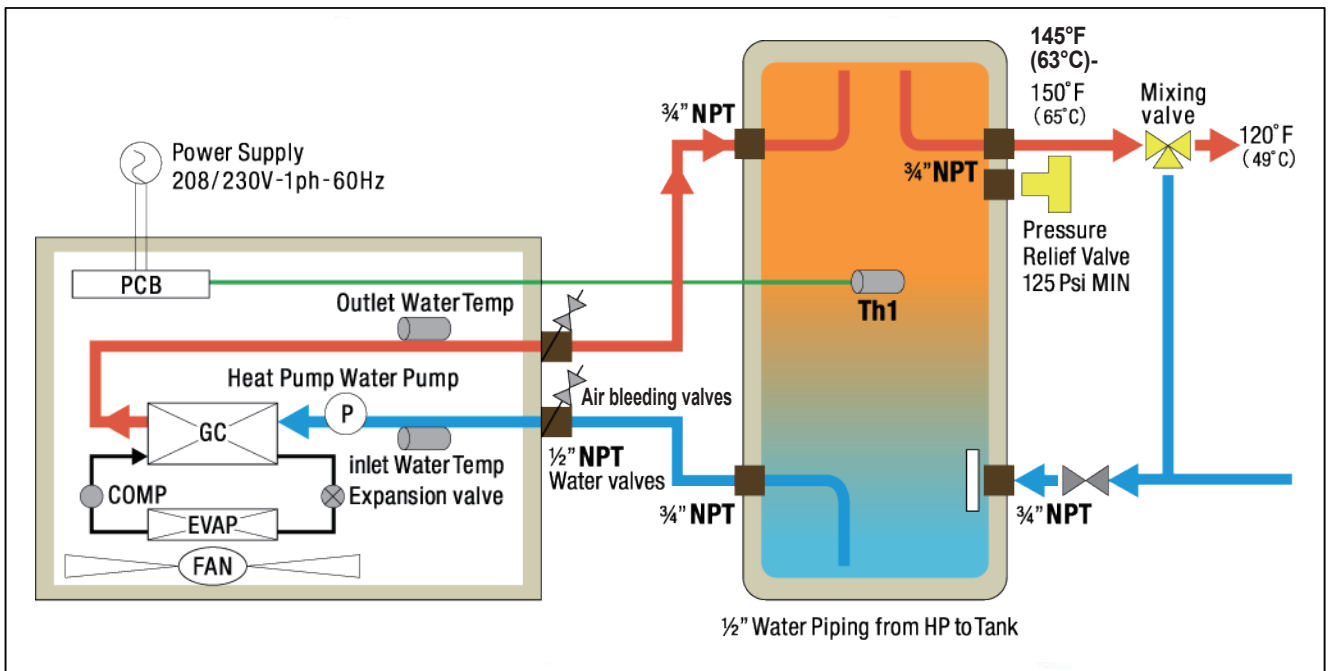



Cold Water & Hot Water Connections on Tank shown are only 3/4" NPT size on SAN-43SSAQA/ECO-43SSAQB & SAN-83SSAQA/ECO-83SSAQB Tanks

Safety precautions



Please ensure you fully observe the precautions.

The following instructions need to be fully followed to prevent any harm to users and others or damage to your property.

■ The extent of the possible harm or damage caused by misuse of the product falls into the following classifications.

 Danger	Indicates an imminently hazardous situation that will result in death or serious injury in case it is not avoided.
 Warning	The column with this classification indicates “the extent of harm that includes the possibility of death or serious injury”.
 Caution	The column with this classification indicates “the extent of harm/damage that includes the possibility of injury or damage to property”.

■ The type of content to be observed can be explained with the following pictorial classifications.

	Indicates content requiring “attention”.
	Indicates content that is prohibited.
	Indicates content with “instructions” that need to be fully followed.

Danger

Hot water heater temperature over 125°F can cause severe burns instantly or death from scalding. Children, disabled and elderly are at the highest risk of scalding. Feel water temperature before bathing or showering.

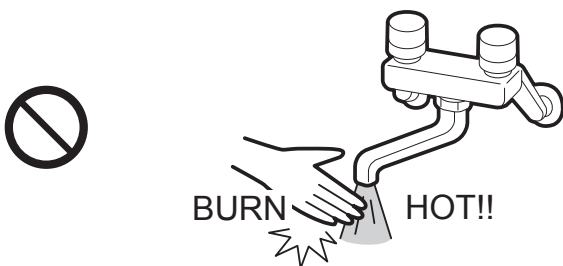

Temperature	Time to Produce a Serious Burn
120°F(49°C)	More than 5minutes
125°F(52°C)	1-1/2 to 2minutes
130°F(54°C)	About 30 seconds
135°F(57°C)	About 10 seconds
140°F(60°C)	Less than 5 seconds
145°F(63°C)	Less than 3 seconds
150°F(66°C)	About 1-1/2 seconds
155°F(68°C)	About 1 second

Table courtesy of Shriners Burn Institute

Warning

If the water heater has been subjected to fire, flood, natural disasters or physical damage, DO NOT operate the water heater again until it has been checked by a qualified service technician.
Failure to do so will cause injury.



Hydrogen gas can be produced in a hot water tank served by this water heater that has not been used for two weeks or more. Hydrogen gas is extremely dangerous since it is flammable.

It is recommended to open the water faucet for few minutes before using any electrical appliance connected to the hot water system.

If hydrogen gas is stored inside of a tank, there is a noise of air bleeding, in case that sound is heard, please do not use fire around the unit.

Do not touch the faucet while hot water is being supplied.



Do not touch



Could result in being burnt by hot water.

Do not touch the relief valve, drainage pipe, drain outlet or drain elbow when inspecting the relief valve or while draining hot water.



Do not touch

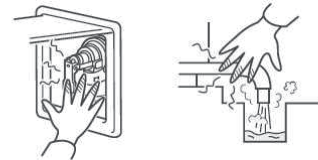

Could result in being burnt by hot water.

Check the water temperature before supplying any hot water or taking a shower.



Could result in being burnt.

Do not touch the heat pump unit pipes or hot-water supply pipes.

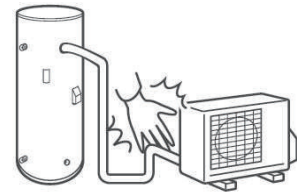

Could result in being burnt.

Please wear gloves when you touch unit.



Warning

Do not use any damaged, altered, or bundled power cords.



Verify that the piping has all been insulated.

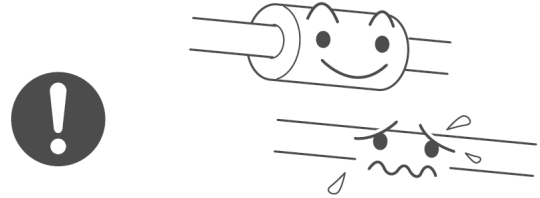

Any of the pipes freezing up and getting damaged could result in scalding or water leaking.

• Please contact the Dealer about insulating the pipes.

Ensure the product is removed from any gas containers, sources of fire and flammable substances.

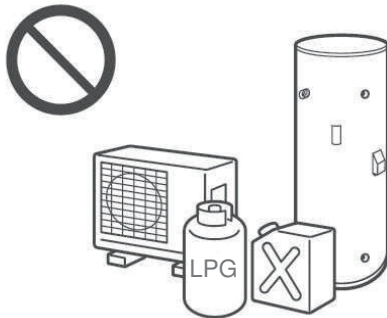

Sparks from the electrical parts of the product could result in fire.

Do not disassemble, repair or alter the product in any way.



Do not disassemble

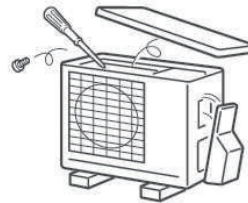

Could result in electric shock or fire.

• Contact the Dealer for repair.

Do not open the front board of the hot water storage unit or the heat pump unit cover.



Do not disassemble

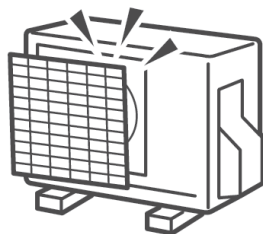

Could result in electric shock.

Do not poke your fingers or a stick into the air inlet (fins)/air outlet of the heat pump unit.



Attention – Rotating object

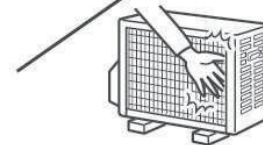
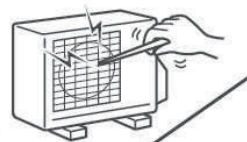

Could result in injury.

⚠ Caution

Do not climb or put anything on top of the unit. Do not apply any force to the piping.

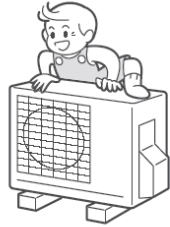

Could result in injuries from a fall or being scalded.

Do not use the heat pump unit if the installation blocks have been damaged.

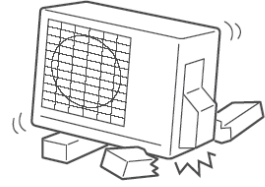

Damaged installation blocks could result in the heat pump unit falling over and causing injury.

Do not put anything susceptible to humidity under the heat pump unit.

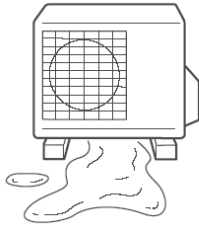

Water could drain out. In addition, condensation could drip from the pipe connections.

Ensure no animal or plant life is placed directly in front of where air is blown from the unit.

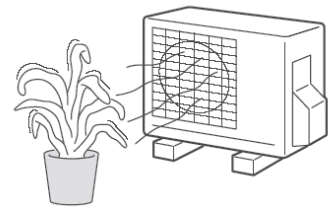

Could result in harm to animal and plant life.

Do not block the air inlet and outlet.

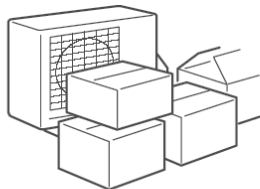

Could harmfully influence performance and lead to failure.

Remove any snow from the units after snowfalls.

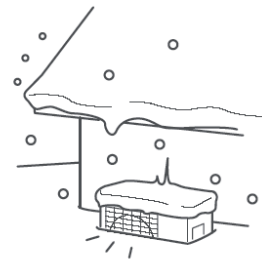

Snow building up around the heat pump unit and hot water storage tank unit could result in malfunction and failure.

Select an installation place with consideration given to neighbors.

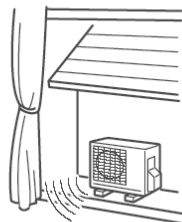

Please select a place where noise and vibration while operating will not bother your neighbours.

Check the installation conditions of the unit.

Installation of the unit in the following places could result in accidents or failure and the performance of the unit not being guaranteed.

- Anywhere the lowest temperature reached is under -26 degrees Fahrenheit
- Indoors (Applies only to the heat pump unit)
- Anywhere not completely flat, unstable or where drainage is difficult
- Ensure not to put anything around the heat pump unit. Could result in poor performance and unexpected problems. In the winter in particular please pay attention to any snow coverage.

- Wipe the unit with a soft dry cloth and do not use chemical items when cleaning.
- Do not use gasoline, benzene, thinners, or any polishing compounds.

Installation Details

This SANCO₂ Heat Pump Water Heater System must be installed by licensed personnel in accordance with local building codes:

- Installing contractor should be licensed by applicable state/province and municipal authorities to install an Electrical & Plumbing product.
- The unit has been designed for heating potable domestic hot water. Any other usage, such as use for DHW in combination with space heating requires both a heat exchanger suitable for local codes to be installed on the system to separate potable and non-potable water and consultation with ECO2 Systems.
- The unit is designed to operate when connected to the water supply with a maximum operating pressure of 75PSI (520 kPa). To ensure the mains pressure does not exceed this, first check incoming cold water mains pressure, and then a pressure regulating device must be connected to the water supply line if the Cold Water mains pressure is above 75 PSI.
-  **DANGER** This system delivers hot water exceeding 120 °F (50 °C). Installation of a temperature tempering device is **MANDATORY** to avoid potential scalds and burns.
- The unit must be stored and transported in an upright position. Failure to do so may render the unit faulty. Such failure is not covered under any warranty agreements.

Failure to comply with the above conditions will void the warranty.

-  **California Proposition 65 WARNING**
This product contains chemicals known to the State of California to cause cancer, birth defects or other reproductive harm.

Trouble Shooting Guide

If you face a problem while using our Heat Pump water heater system, please check the following table prior to calling for support.

Status	Considerable Causes	Action to Take
No hot water comes out of water tap Temperature of hot water is too low	Small or no hot water is left in the storage tank.	<ul style="list-style-type: none"> - Stop using hot water and wait for about 1 hour - Consider a change of the electricity supply off-peak mode (Length of power-supply hours may be too short for the water heating cycle to cover the hot water consumption)
	Air bleeding procedure from the heat pump system may be insufficient.	- Open the water drain plugs on the Heat Pump Unit to bleed air from water circuit. (Be careful for burning)
	Filter on cold inlet connector may be blocked.	- Check the filter and remove if there is any blockage
	Water flow speed may be dropped due to the heat pump piping bend, blockage or crush.	- Check for any piping bend or crush and remove if any
	Pipes may be frozen.	- If frozen area is found on the piping, melt the ice on the pipe and provide a heat insulation
	Stop valve is closed.	- Open the valve
	Air absorption is not sufficient due to a blockage on the evaporator.	-Remove the object blocking the air flow through the evaporator (e.g. fallen leaves, grass, snow, etc.)

For those problems not listed in the list above, an inspection provided by a skilled engineer is required. Please contact your local distributor.

Caution:

Do not shut the electricity supplied to the Heat Pump system off even if you go away from home and do not use hot water for a long while.

If the system is equipped with freeze protection heaters, also do not shut the power supply to the heaters.

Failure to do so may cause a crack on the pipes due to the pipes getting frozen.

Error Codes

When an error has occurred, a red LED on the operation panel turns on and an error code is displayed on the LED display. The panel does not turn to the display sleep mode while the error code is shown.

Figure 2 Error Code example

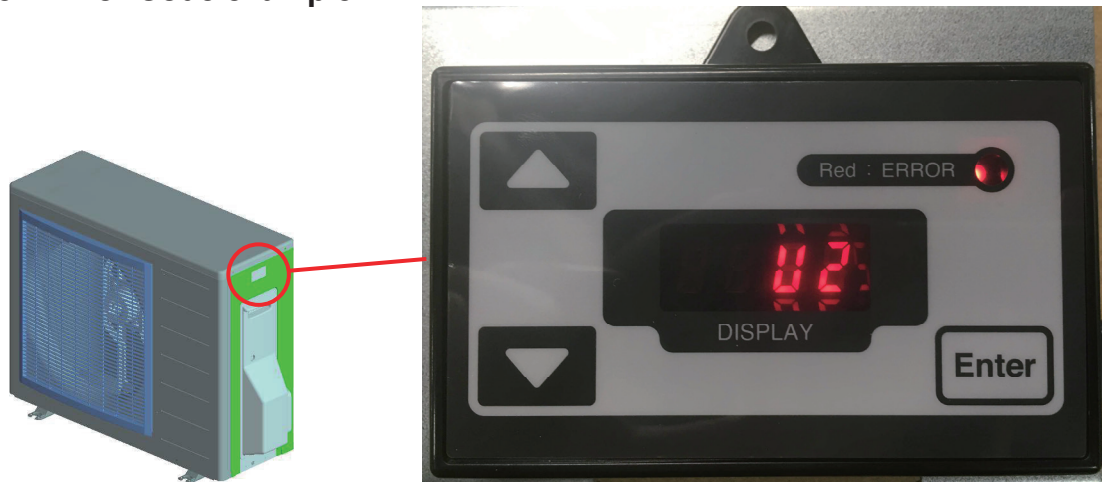

Below is the list of the error codes. If the corrective action does not solve the error problem, a malfunction of the PCB is highly likely.

Error code	Error contents	Error code	Error contents
E1	Main PCB error	H9	HP ambient(outdoor) temperature thermistor error
E2	Control PCB error	HC	HP water outlet(outgoing) temperature thermistor error
E6	Compressor booting error	HJ	Water circuit error
E7	Fan motor locked	J3	HP discharge temperature thermistor error
E8	High inlet current error	J5	HP suction temperature thermistor error
E9	Water circulation pump error	J6	HP defrost temperature thermistor error
EC	High water outlet error	J8	HP water inlet(return) temperature thermistor error
F3	Discharged temperature error	L4	High temperature of module error
F5	Communication error between main PCB to control PCB	L5	High outlet current error
FA	High pressure side error	L7	Control PCB error
H0	High water outlet error	P4	Module temperature thermistor error
H3	Pressure switch error	U0	Refrigerant leakage error
H6	Compressor revolution error	U2	High voltage error
H7	Tank temperature thermistor error		
H8	Current error		

Filling the System & Bleeding Air

CAUTION : Be sure to follow the procedure below.
If the procedure is not followed, the pump may run idle and be damaged.

The following steps must be taken to ensure all air is bled from the system.
Incorrect bleeding of air may cause the water temperature to vary during operation.

- Ensure that all piping to tank unit and heat pump unit are installed and connections are tight, then open the Cold Water Supply Valve to the system.
- Push up the lever on the PR valve to open, and fill the tank unit with water. Confirm that water comes out of the relief valve, and then close the lever.
- Open the hot water faucets to bleed air from the house piping system.
- Close the faucets after no air is seen in the water.
- Open the 3 x water bleed screws on the heat pump unit. Close the plugs after no air is seen in the water.
- Leave the hot water faucets open for 3 minutes. Close the faucet after no air can be seen in the water.
- Supply power to the heat pump unit.
- Display shows "1200" then "Clock setting mode" is started with operating "Air bleeding process" at the same time.
- In case finish time setting or nothing is operated for 1 minute, "Clock setting mode" is terminated and "APon" will be displayed on the monitor.
- "Air bleeding process" will be done in 5 minutes. Once it's finished, current time will be shown on monitor.

CAUTION : One Air bleeding screw is located underneath the heat pump unit!

Figure 3: Air bleeding process

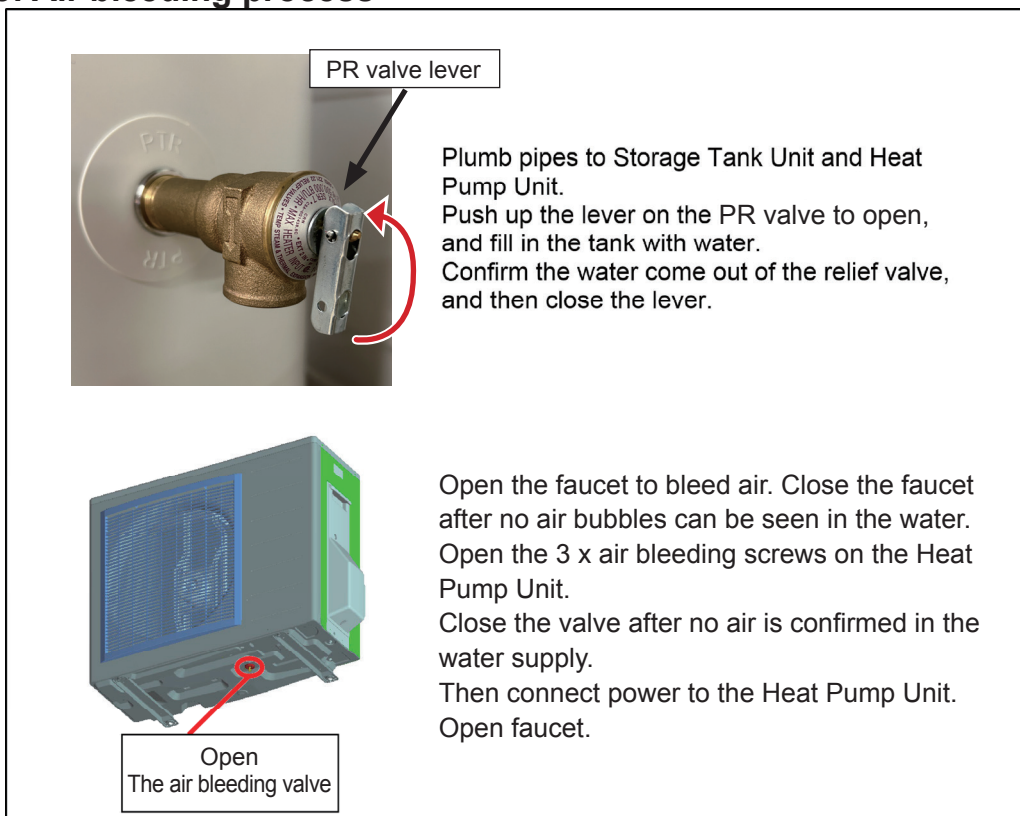

Mains Power/Electrical Installation

DANGER

- All Electrical Wiring should be done in accordance with the latest edition of the National Electrical Code (NEC) and all local State/Province and Municipality codes.
- The power requirement for the system is a dedicated 15 amp circuit fitted with a circuit breaker. This circuit may be connected to constant power or off-peak power.
- A local disconnect should be installed adjacent to the Heat Pump unit in accordance to NEC and local codes.
- Installation of this system must be carried out only by a qualified installation technician (electrical or plumbing).

Electrical Connections

Electrical installation should only be done by a licensed electrician
Outline of electrical system connections

- Breaker size and wiring must be sized per NEC rules for the rating plate amperage, MCA and MOP or Max Circuit Breaker.
- **Power Supply is 208/230V-1Ph-60Hz**
- **Verify that the tank unit is full of water and the water shut off valves are open before turning on the power.**

How to Connect Main Power

- Remove the power box cover (Philips head screwdriver required)
- Connect the power wiring to the terminal block per the wiring diagram/manual.
- Ensure ground wire is connected.
- Secure the power supply wiring below the terminal block with the screw clamp fitting.
- Re attach the power box cover to the heat pump unit.

Figure 4: Connect power

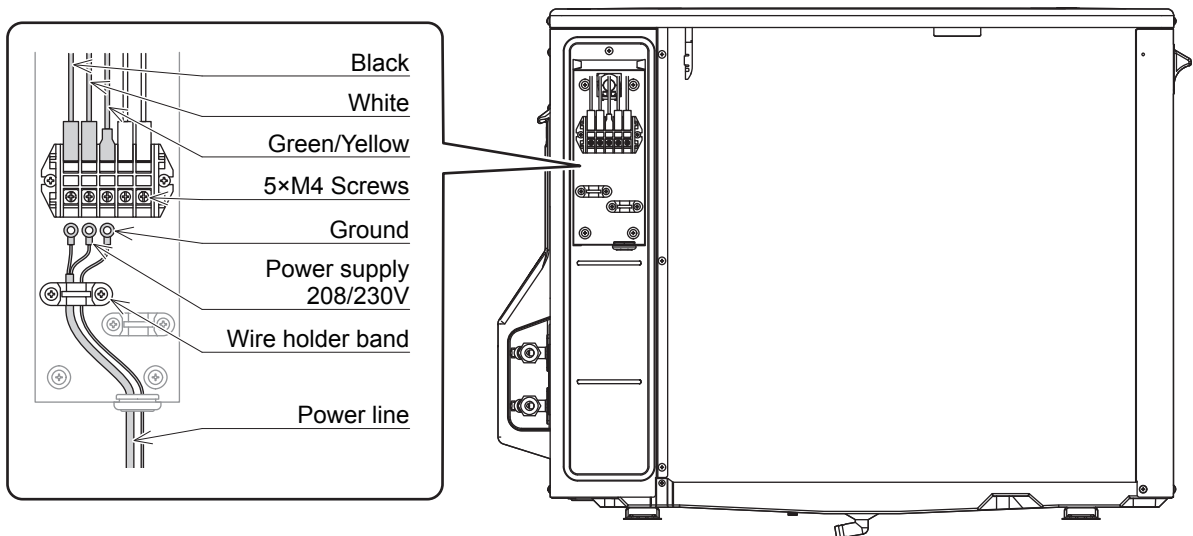

- Heat Pump 208/230V Power Wiring must use solid copper wire.
- Appropriately sized ring or fork terminals are recommended for easier connection.

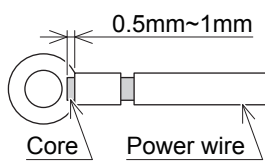

How to Connect Thermistor Cable and Modbus Cable

- Remove the piping cover.
- Connect the thermistor cable and the modbus cable line to the terminal block.
- Fix the thermistor cable and the modbus cable with the code clip and conduit clip.
- Attach the piping cover back on the heat pump unit.

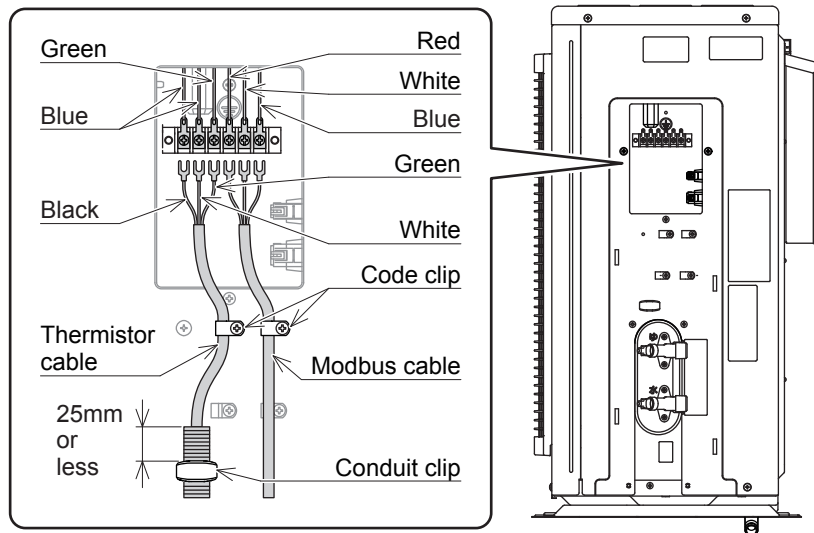

Standard System Operation

- If the block out time function is selected the unit will not operate during the block out times – this function is typically used on installations that have time of use electricity tariffs.
- The system will not run if the power supply is cut off.

System Operation If Connected to Dry Contact

- There are no special settings for the Dry contact input. The system will run once dry contact input becomes available and the temperature in the tank drops below the set point of the tank thermistor.
- If the Unit is connected to Dry Contact and Hot Water consumption has been higher than normal, hot water may not be available until the closure of the Dry Contact.
- Daily frequency and amount of hot water consumption may also affect the duration of the heating cycle operation.

Select the electrical supply mode that best suits the customer's hot water consumption. The type of off-peak connection may need to be changed if hot water supply is not maintained as required.

Figure 5: Outline of electrical system connections

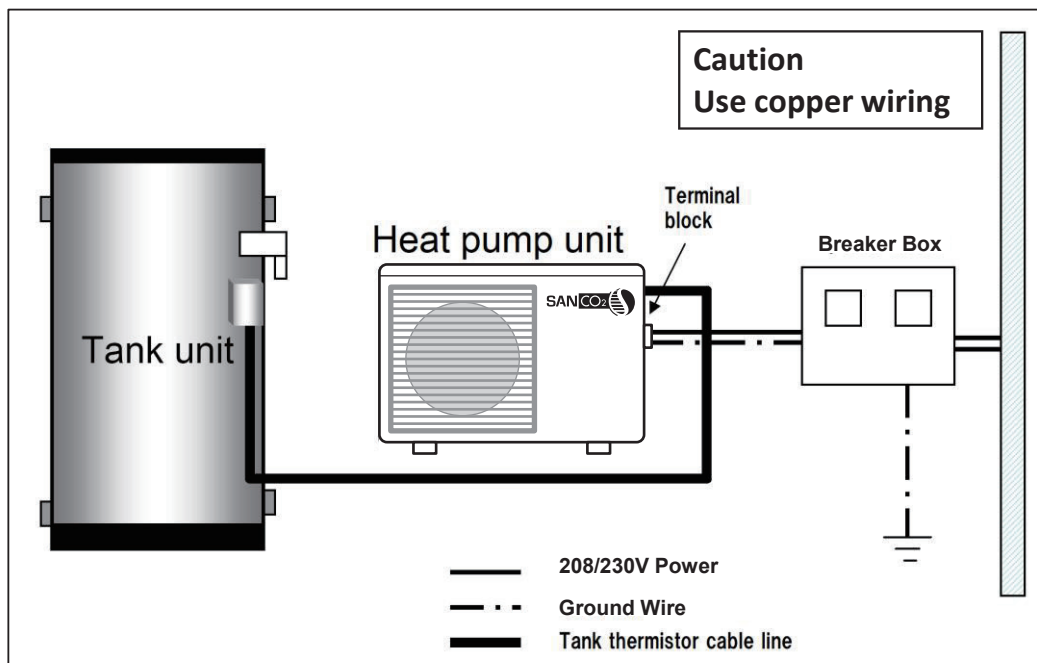

The basic system installation is now complete; the unit is now ready for initial filling, air bleeding and then start up.

Check the Installation against the Installation Check list provided at the end of this manual

Ensure that the work site is tidy; ECO2 Systems LLC recommends the use of Slim Duct or Fortress product to cover water piping on the outside of the house

Water Supply Quality

Chloride, Water Hardness and pH

In high chloride water supply areas, the water can corrode some parts and cause them to fail. Where the chloride level exceeds 0.1 ounces per gallons (200 mg/litre) or Water Hardness level exceeds 0.1 ounces per gallons (200 mg/litre) warranty does not apply to the heat pump unit and tank unit. pH is a measure of whether the water is alkaline or acid. In an acidic water supply, the water can attack the parts and cause them to fail. No warranty applies to the heat pump unit and tank unit where the pH is less than 6.5 or more than 8.0. The water supply from a rainwater tank unit in a metropolitan area is likely to be corrosive due to the dissolution of atmospheric contaminants. Water with a pH less than 6.5 may be treated to raise the pH. It is recommended that an analysis of the water from a rainwater tank be conducted before connecting this type of water supply to the system.

Figure 6 Chlorides and PH

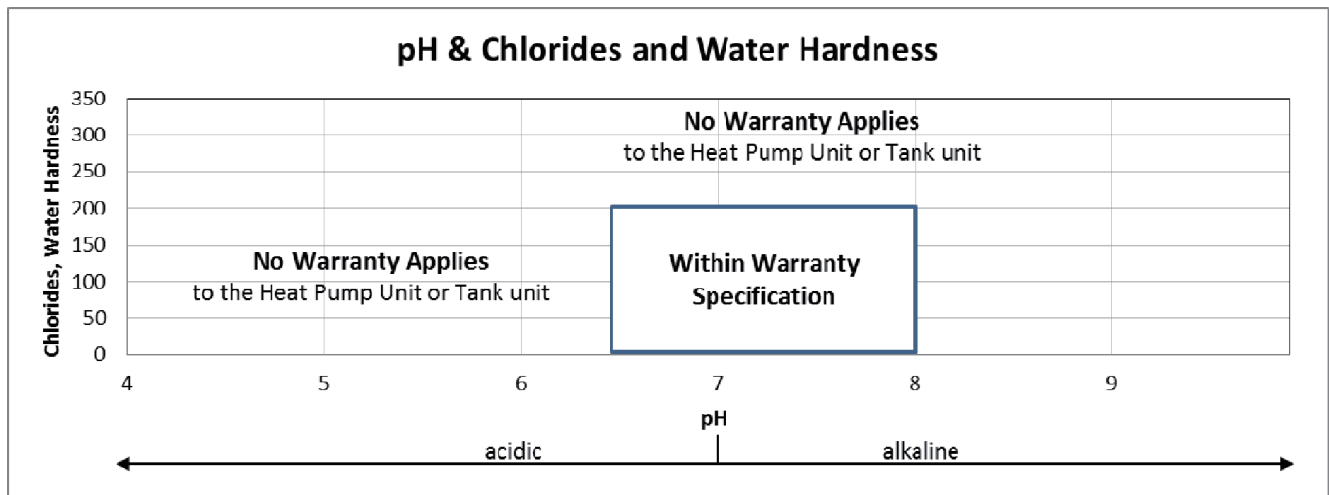

Technical Data

Storage Tank Dimensions

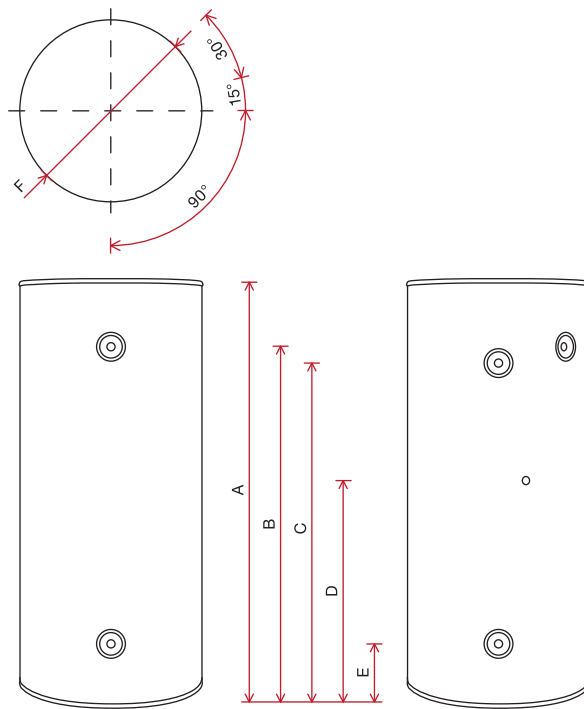

Tank Model No:	ECO-43SSAQB /SAN-43SSAQA	ECO-83SSAQB /SAN-83SSAQA	ECO-119GLBB /SAN-119GLBK*
A Height	38 ^{-1/8} "	68 ^{-7/8} "	63 ^{-3/5} "
B Hot Water Outlet & PR Valve	29 ^{-1/2} "	60 ^{-1/4} "	56"
C Heat Pump Return	29 ^{-1/2} "	60 ^{-1/4} "	60 ^{-1/4} "
D Sensor Port	14 ^{-1/2} "	40 ^{3/8} "	56"
E Cold Water Inlet / Cold Water to HP	8 ^{-3/4} "	8 ^{-3/4} "	4"
F Diameter	24 ^{-1/2} "	24 ^{-1/2} "	28"
Weight (lbs)	88 lbs	115 lbs	345 lbs
Tank Capacity (gallons)	43 gallons	83 gallons	119 gallons
Warranty	15 years	15 years	10 years*

Connection Sizes	
Cold Water Inlet	3/4" NPT(1 1/2" ECO-119GLBB/SAN-119GLBK)
Hot Water Outlet	3/4" NPT(1 1/2" ECO-119GLBB/SAN-119GLBK)
Cold Water to Heat Pump	3/4" NPT
Hot Water Return from Heat Pump	3/4" NPT
Pressure Relief Valve Setting (Psig)	150 Psig

*ECO-119GLBB/SAN-119GLBK tank is a glass-lined steel tank with a 10 year warranty.

Note: Materials and specifications are subject to change without notice.

GS5-45HPC/GS5-45HPC-D Dimensions

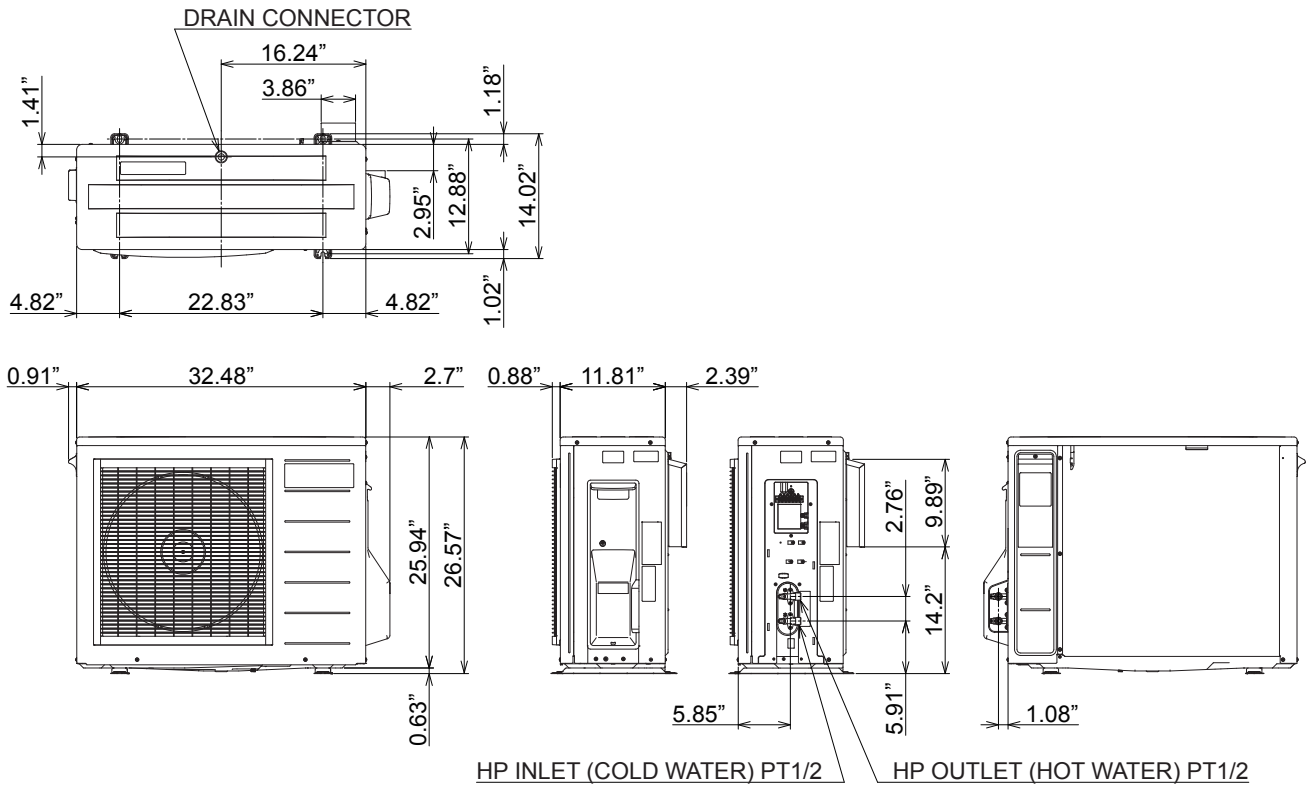

Unit : inch

Specification

Refrigerant type		R744(CO2)
Refrigerant Change		25.4oz (720g)
Hot Water Temperature		145/150°F
Product weight	GS5-45HPC	108lb (49kg)
	GS5-45HPC-D	110lb (50kg)
Thermal capacity		4.5 kw
Power consumption of drain pan heater ※		132W
Fan motor FLA		0.3A / 30W
Water pump FLA		0.6A / 60W
Compressor RLA / LRA		5.0A / 9.0A
MCA		7.2A
Circuit Breaker Size		15A
Design Pressure(High/Low)		1740/1160 PSI
Max inlet water temperature		100°F
Protection Raining Class		IPX4
Max, Operating water Pressure		125 Psig

※GS5-45HPC-D only

Residential Warranty Policy covering the following Model #'s :
Heat Pump : GS5-45HPC & GS5-45HPC-D
Storage Tanks : ECO-43SSAQB, SAN-43SSAQA, ECO-83SSAQB,
SAN-83SSAQA, ECO-119GLBB, SAN-119GLBK

Warranty Conditions as of April 1st 2024 to the Original Owner Only

1. Warranty period

Subject to the Warranty Conditions and Exclusions stated below, the Eco2 Systems LLC Heat Pump Water Heater System with the corresponding model numbers warranted in Residential / Combi DHW & Heating applications **ONLY** (For Commercial applications as defined the warranty is covered in a separate document) as follows:

1-1. Residential DHW application ; Heat Pump unit

Eco2 Systems LLC warrants all parts & labor on the SANCO₂ Residential system for a period of 3 years from date of installation and a further 7 years on Parts only excluding shipping costs.

Labor costs are paid per the payment cost schedule published by Eco2 Systems LLC and revised from time to time at Eco2 Systems LLC's requirement (Exhibit A).

Should at any time during the 10 year Parts warranty any component directly part of the CO₂ refrigerant circuit fail, where replacement of that component would require opening of the refrigerant circuit, Eco2 Systems LLC will replace the Heat Pump unit in it's entirety. If this failure occurs in the first 3 years of operation, then Labor costs will be paid per Exhibit A.

1-2. Residential DHW application ; Tank

Eco2 Systems LLC warrants that the *ECO-43SSAQB, SAN-43SSAQA, ECO-83SSAQB & SAN-83SSAQA* tanks will be free from defects for 10 years at 100% replacement, and for a further 5 years under a pro-rated scale, culminating in warranty ending after Fifteen years from date of installation.

Failure in Year 11:	80% of replacement value
Failure in Year 12:	60% of replacement value
Failure in Year 13:	40% of replacement value
Failure in Year 14:	20% of replacement value

ECO-119GLBB & SAN-119GLBK tanks have a warranty of 10 years only at 100% replacement value.

1-3. Combined DHW/Heating application

When used in a Combined DHW/Heating System application, the winter design (99%) temperature must be above 25°F and must be with a single heat pump unit serving a heating load of less than 10,000 Btu/h with the addition of a minimum DHW demand of 20 Gallons per day otherwise a SANCO₂ system will have the warranty approval denied.

The warranty period is that stated below, which is not the same period as the Residential DHW system.

1-3.1. Combined DHW/Heating application; Heat Pump unit

Eco2 Systems LLC warrants all parts & labor on the SANCO₂ Combi Heat Pump unit for a period of 1 year from date of installation and a further 4 years on Parts only excluding shipping costs. Labor costs are paid per the payment cost schedule published by Eco2 Systems LLC and revised from time to time at Eco2 Systems LLC's requirement.

1-3.2. Combined DHW/Heating application; Tank

Eco2 Systems LLC warrants all parts & labor on the SANCO₂ Storage Tank for a period of 1 year from date of installation and a further 4 years on Parts only excluding shipping costs. Labor costs are paid per the payment cost schedule published by Eco2 Systems LLC and revised from time to time at Eco2 Systems LLC's requirement.

2. Warranty Conditions – All Residential Applications

- 2-1.** The Eco2 Systems LLC Heat Pump Water Heater System must be installed in accordance with the installation instructions supplied with the Heat Pump Water Heater System, all relevant industry practices and in accordance with all applicable relevant plumbing codes plus statutory/local requirements of the state/province/municipality of the location where the water heater is installed.
- 2-2.** Where a failed component or Heat Pump Water Heater System is replaced under warranty, the balance of the original warranty period will remain effective. The replaced part or complete new Heat Pump Water Heater System does not carry a new warranty.
- 2-3.** Warranty period only applies from the verified date of system installation, if such a date cannot be verified then the warranty will be deemed to have started using a date calculated after 2 (two) months have elapsed from the date of unit manufacture.
- 2-4.** Where the Heat Pump Water Heater System is installed in a position that does not allow safe operating practices, such as not installing a properly size metal drain pan if installed in an area where leakage from the tank or it's connections would result in damage to the area adjacent to the heat pump or the storage tank.
- 2-5.** The cost of accessing the site safely, including the cost of additional materials handling and/or safety equipment, shall be the owner's responsibility.
- 2-6.** The warranty only applies to the Heat Pump Water Heater System (heat pump & storage tank) and original or genuine (company) component replacement parts and therefore does not cover any plumbing or electrical parts supplied by the installer and not an integral part of the Heat Pump Water Heater System. Such parts would include but not limited to; pressure regulating valves, isolation valves, solenoid valves, electrical switches, pumps, trace heating, fuses or any other field supplied parts used in the installation of the Eco2 Systems LLC Heat Pump Water Heater system.

- 2-7. The Heat Pump Water Heater System must be sized to the hot water demand in accordance with the guidelines in the current Eco2 Systems LLC Heat Pump Water Heater System literature and application guides and training information.
- 2-8. This warranty is for parts only, any and all labor costs associated with diagnosis, removal of the faulty part and installation of replacement parts will solely be the owner's responsibility except where covered by the labor warranty section of this warranty.

3. Warranty Exclusions

Repair and replacement work will be carried out as set out in the Eco2 Systems LLC Heat Pump Water Heater System warranty. However the following exclusions may void the warranty and may incur additional service charges and/or cost of parts:

- 3-1. Accidental damage to the Heat Pump Water Heater System or any component, including: Acts of God, failure due to misuse, incorrect installation, attempts to repair the water heater other than by an Eco2 Systems LLC accredited service agent or the Eco2 Systems LLC service dept.
- 3-2. On inspection of the failed system or part, and where it is found there is nothing wrong with the Heat Pump Water Heater System; where the complaint is related to excessive discharge from the temperature and/or the pressure relief valve due to high incoming cold water pressure over 75 Psi; where there is no flow of hot water due to faulty plumbing; where water leaks are related to plumbing and not the Heat Pump Water Heater System or its components; where there is a failure of electricity or water supplies; where the supply of electricity or water does not comply with relevant codes or acts or is of the incorrect voltage, phase and amperage as required by the system; Installation of the GS5-45HPC & GS5-45HPC-D heat pump(s) with other storage tanks that have not been specifically approved in writing by Eco2 Systems LLC.
- 3-3. Where the Heat Pump Water Heater System or its component has failed directly or indirectly as a result of excessive incoming water pressure above 75 Psi.
- 3-4. The factory supplied pressure relief valve or an ASME approved valve with the same pressure specification has not been installed or the valve outlet is blocked or corroded.
- 3-5. Where the heat pump or storage tank has rusted or failed as a result of a corrosive atmosphere.
- 3-6. Where the unit fails to operate or fails because of ice formation in the piping to or from the Heat Pump Water Heater System due the lack of Trace Heat cable, Freeze Protection Valve kit and a power outage to the GS5-45HPC and GS5-45HPC-D Heat Pump. Suitably sized self-regulating trace heating must be installed around the exposed supply and return piping to and from the heat pump including around the unit connections whenever the Heat Pump unit is installed in a location where the winter ambient temperature will fall below 27°F. Freeze Protection valves must be installed on the Cold Inlet and Hot Outlet piping within 6" from the piping connections to the Heat Pump unit.
If a Power Outage occurs to the Heat Pump units at an ambient temperature that is either below 27°F or could drop below that 27°F ambient temperature at any time when the Heat Pump is not powered nor have Freeze protection valves been installed on the piping, then potential freezing of the piping to and from plus internal piping and components of the Heat Pumps cannot be covered under warranty.

- 3-7. Where the Heat Pump Water Heater System is located in a position that does not comply with the Heat Pump Water Heater System installation instructions or relevant statutory requirements, causing the need for major dismantling or removal of cupboards, doors or walls, or use of special equipment to move the unit to floor or ground level or to a serviceable position.
- 3-8. Repair and/or replacement of the Heat Pump Water Heater System due to scale formation when the incoming water shows a water hardness above 200ppm or 12 grains in the waterways or the effects of either corrosive water or water with a high chloride level together with a PH level of below 6.5 or above 8.0. when the water heater has been connected to a scaling or corrosive water supply or a water supply with a high chloride or low PH level as outlined in the *Owner's Guide* and *Installation Manual*
- 3-9. Replacement due to cosmetic reasons, or for reasons of noise, taste, odor; discolored and/or rusty water.
- 3-10. Failure of a Combined DHW/Heat System where the Heating application has been used to provide “construction heat” in an unoccupied unfinished, unfurnished building for the purposes of heating the structure so that other building trades or building processes can be completed.
- 3-11. Internet purchase: Any Eco2 Systems LLC Heat Pump Water Heater Systems purchased on the internet are not eligible for warranty. The system must be purchased from an Eco2 Systems LLC certified distributor/contractor and installed by a licensed plumbing/HVAC contractor.
- 3-12. Closed Loop : Application and Installation of a loop for the piping between the GS5 Heat Pump and the Storage Tank where a field installed Pump circulates Cold Water from the Tank to Secondary Tees in the Loop that have the GS5 units draw Cold Water from the loop and return Hot Water back to the Loop to be returned to the Tank(s).

Subject to any statutory provisions to the contrary, this warranty specifically excludes any and all claims for damage to furniture, carpets, walls, foundations, personal property or any other consequential loss either directly or indirectly due to leakage from the Heat Pump Water Heater System, or due to leakage from fittings and/or pipe work of metal, plastic or other materials caused by water temperature, poor workmanship or other modes of failure. Eco2 Systems LLC shall not be liable by virtue of this warranty or otherwise for damage to any persons or property, whether direct or indirect, and whether arising in contract or in tort.

This warranty gives you specific legal rights, and you may have other rights which vary under the laws of each state. If any provision of this warranty is prohibited or invalid under applicable state law, that provision shall be deemed to be ineffective to the extent of the prohibition or invalidity, but without invalidating the remainder of the affected provision or the other provisions of the warranty.

Exhibit A: Labor Costs

Labor costs are paid per the payment cost schedule published by Eco2 Systems LLC and revised from time to time at Eco2 Systems LLC's requirement.

Labor warranty specifically excludes (unless agreed to in writing prior to service being carried out) costs associated with travel to and from jobsites, distributors or contractors place of business, initial fault diagnosis and subsequent work due to incorrect diagnosis of fault or additional faults due to poor replacement practice of the failed part, delivery costs associated with replacement parts or units, or any other such administrative costs. These costs are to be the responsibility of the owner.

Labor expense reimbursement by part or action (USD) as of 04/01/2024

i. PCB replacement	\$125
ii. Thermistor replacement	\$100
iii. Controller replacement	\$100
iv. Fan motor replacement	\$100
v. Pump replacement	\$125
vi. Expansion valve coil replacement	\$100
vii. Other miscellaneous component replacement	\$125
viii. Fan blade replacement	\$100
ix. Complete unit replacement (Heat Pump or Tank)	\$235

Registration for Warranty

In order to register your system for warranty purposes, please complete the details of your purchase below, detach and mail to

ECO2 Systems LLC
PO Box 1358,
Walled Lake MI 48390

Name _____
Mailing address _____ State _____
Postcode _____
Product Details:
Heat Pump Serial Number (from label on right end) _____
Hot Water Tank Serial Number (label on tank) _____
Date of Purchase/Installation ____/____/20____
Suppliers Name _____

You may register your product via email, to '<https://www.eco2waterheater.com/>. Simply send an email containing the same details as shown above

Please Note: Similar registration details will be provided to ECO2 Systems LLC by your supplier/installer to validate their claim for warranty support; it is essential that the dates of supply/installation correspond to within one month.

Memo

A series of horizontal dashed lines for writing a memo.

